

分解图 / EXPLODED VIEW

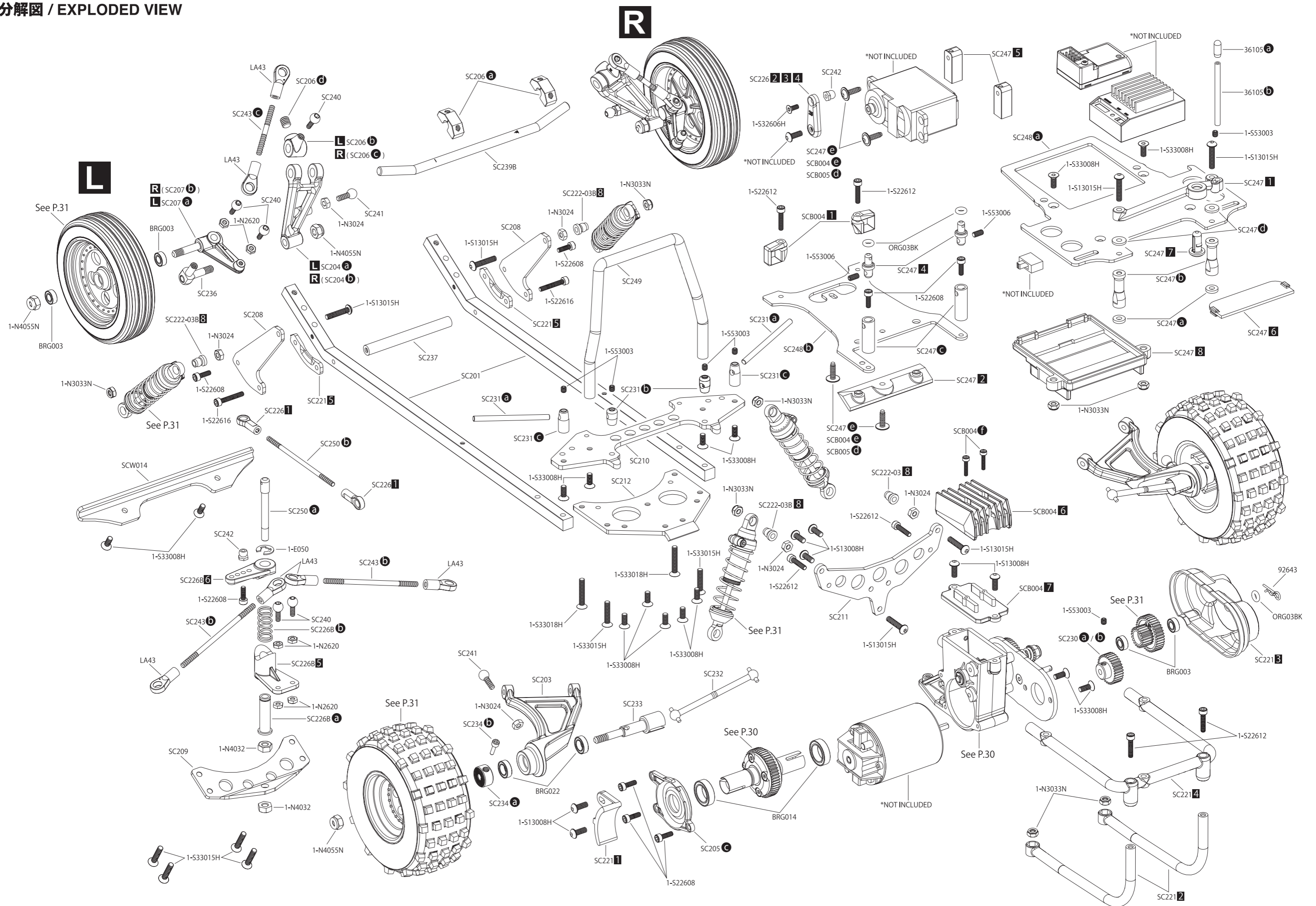

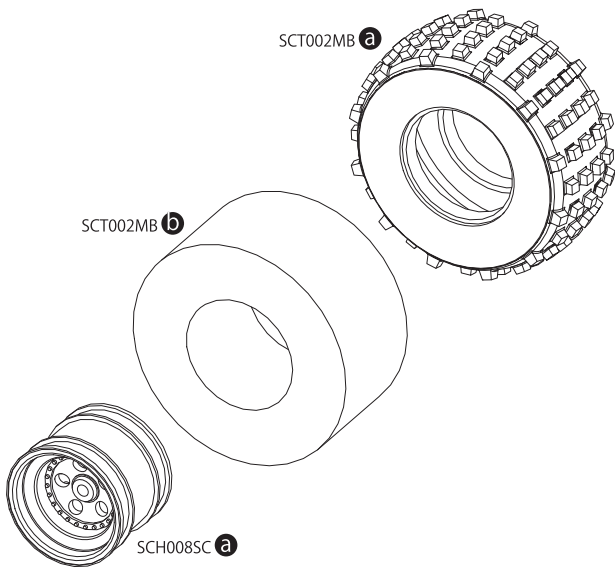

Front SC222R

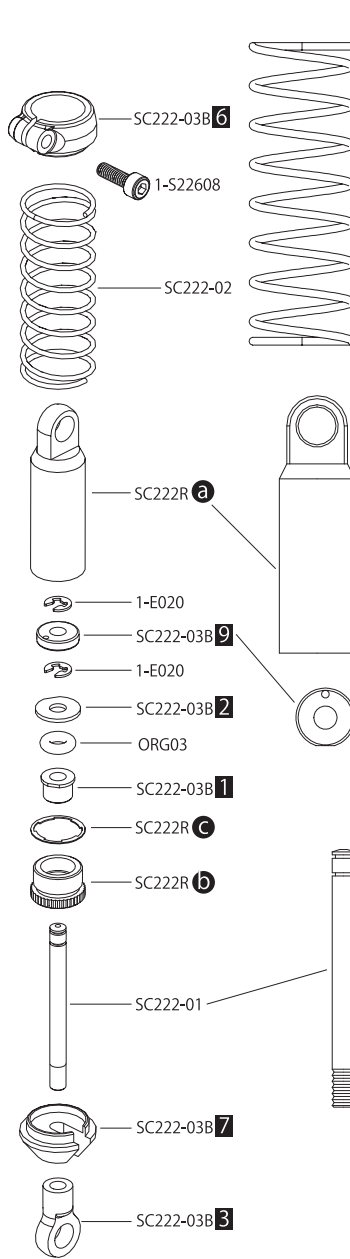

Rear SC223R

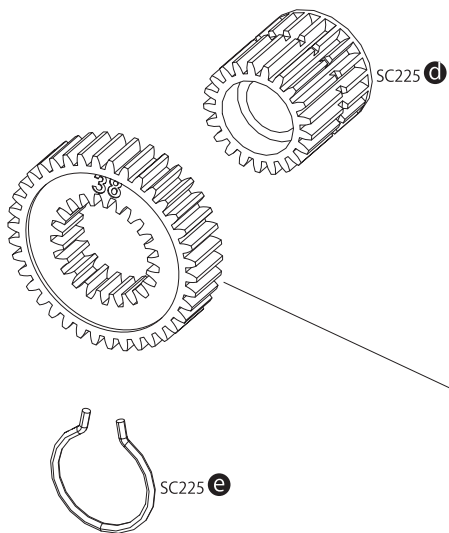
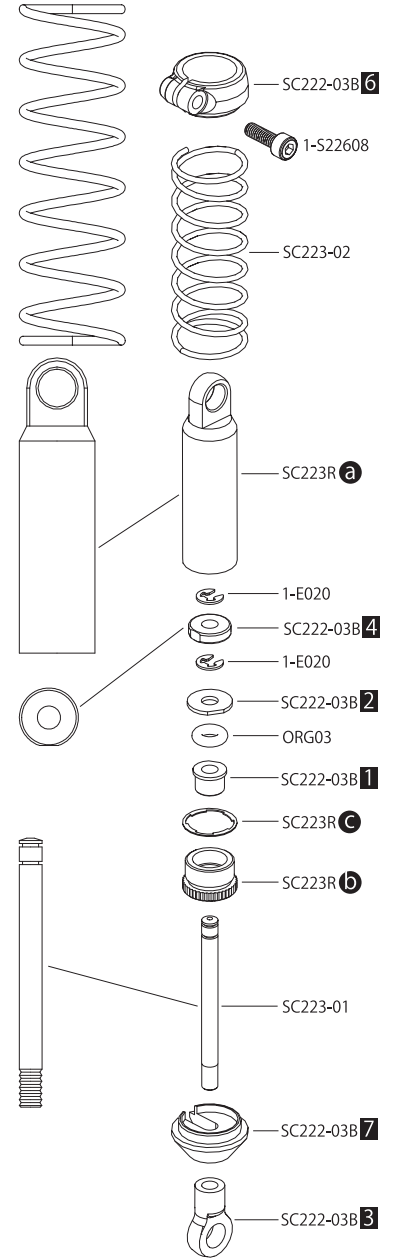

Gear Ratio Chart

1:1

6.9 : 1

8.3 : 1

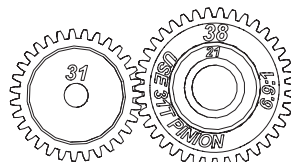

SC230 **a**
Motor Pinion
31T Gear

SC225 **c**
Spur Gears
38T

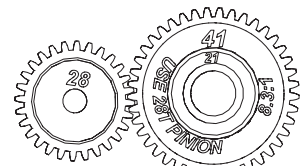

SC230 **b**
Motor Pinion
28T Gear

SC225 **d**
Spur Gears
41T